

A - TOP 1 PC	B - SEAT 2 PCS	C - LEG 3 PCS	D - BOLT 18 PCS	E - NUT 18 PCS	F - WRENCH 1 PC	G - HEX KEY 1 PC

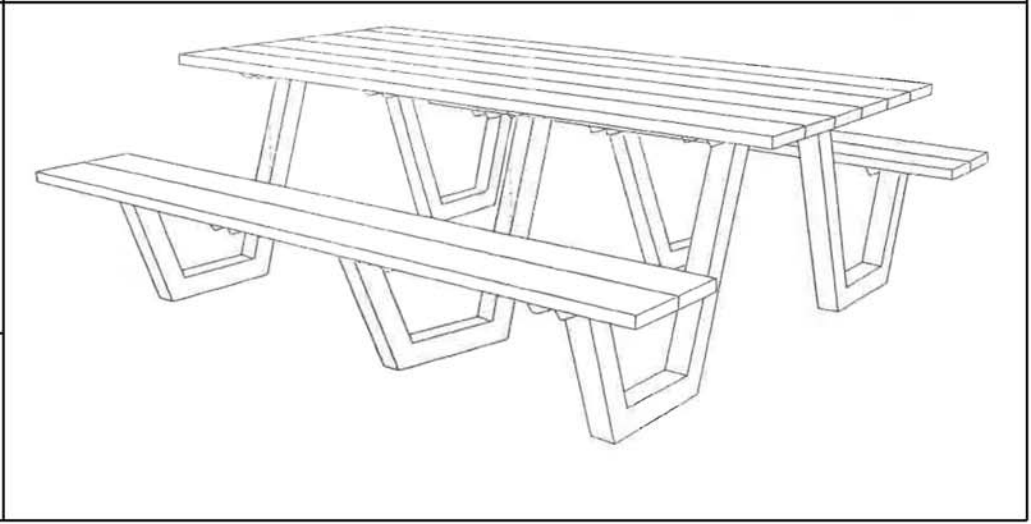
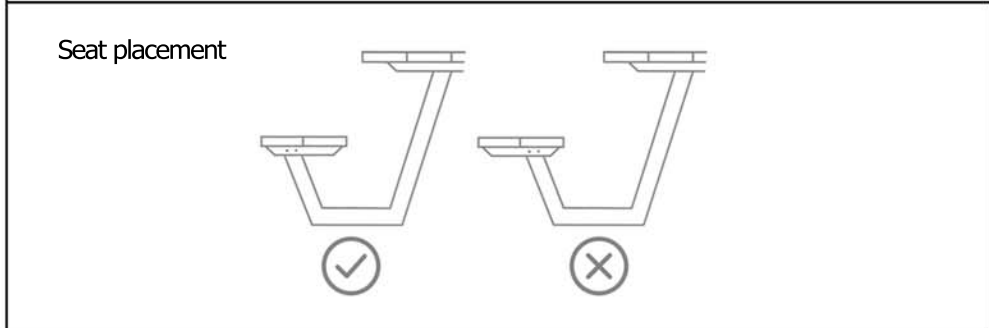
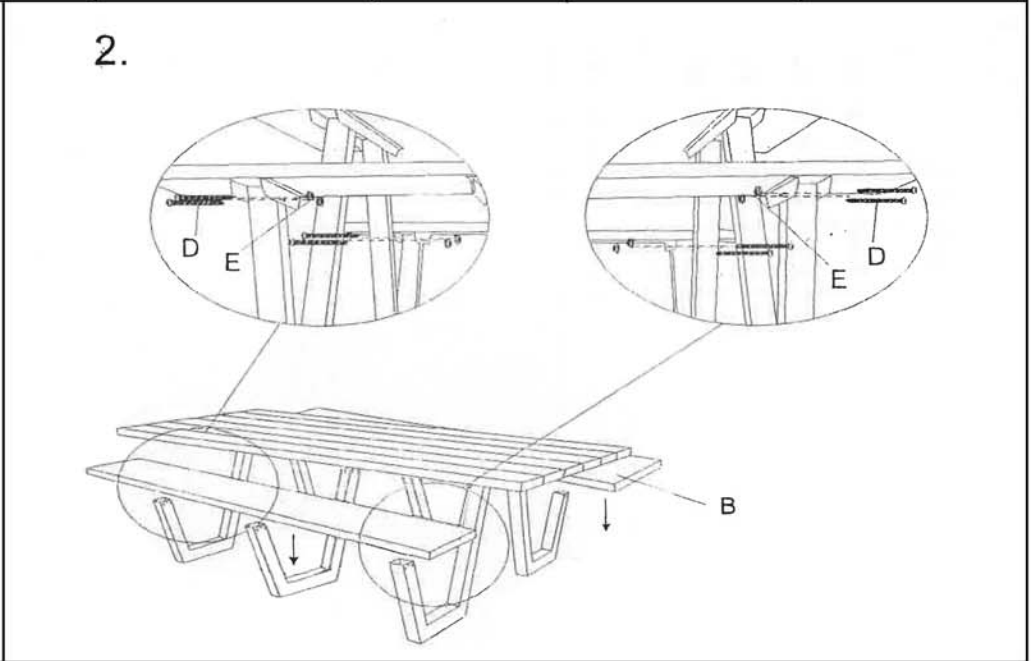
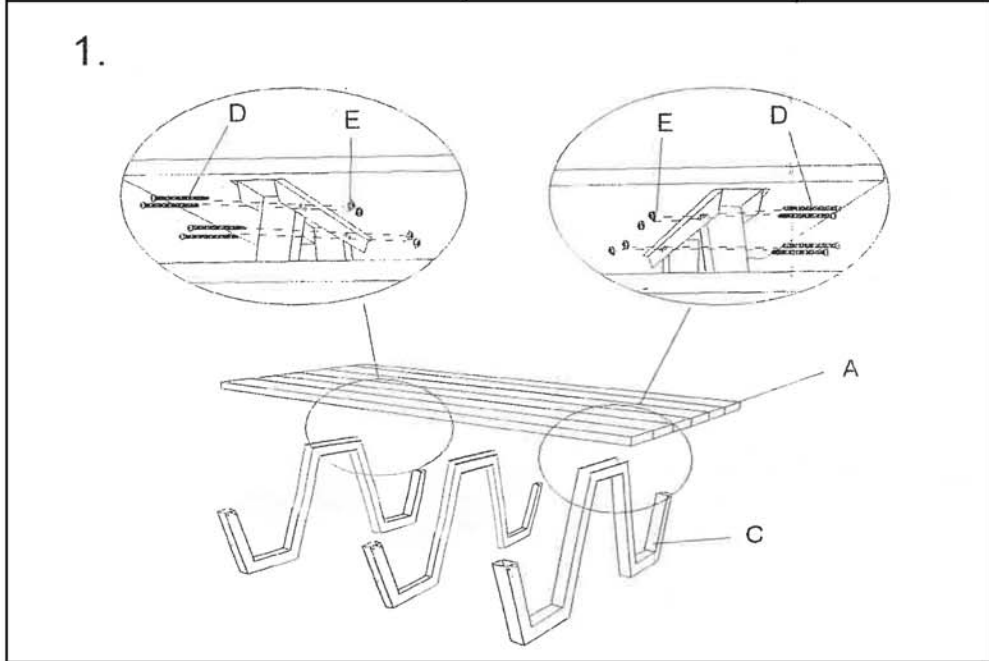

SID Picnic Table # 1821  
**emuamericas, llc**  
 T: 303.733.3385  
 email: info@emuamericas.com